

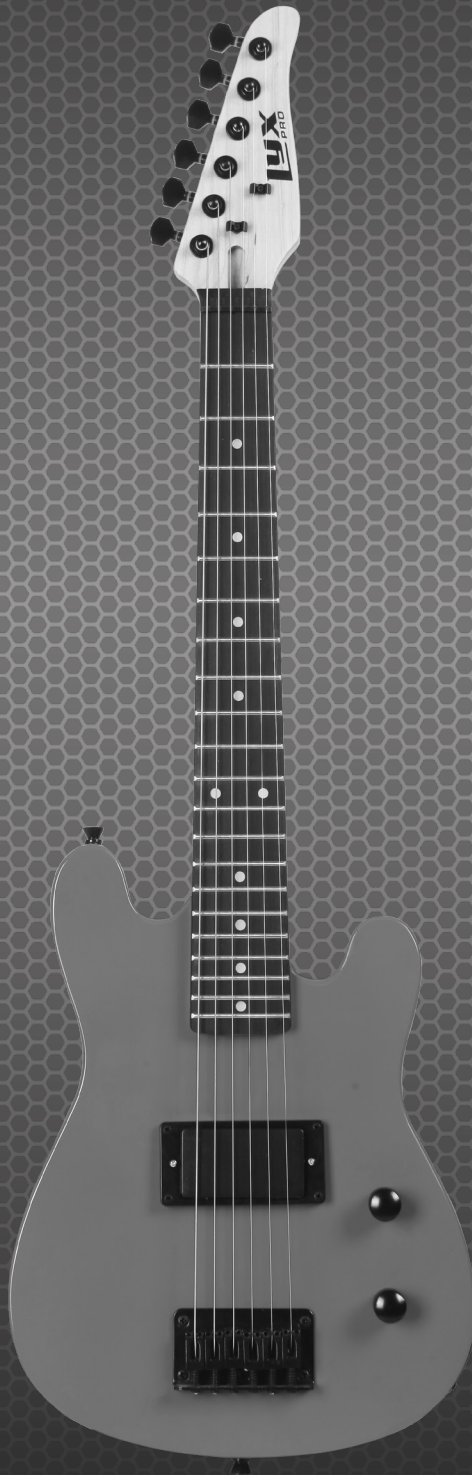

# JUNIOR ELECTRIC GUITAR & STARTER KIT

## User Manual



30"



36"

## Introduction

Thank you for purchasing the LyxPro Junior Electric Guitar & Starter Kit. This User Guide is intended to provide you with guidelines to ensure that operation of this product is safe and does not pose risk to the user. Any use that does not conform to the guidelines described in this User Guide may void the limited warranty.

Please read all directions before using the product and retain this guide for reference. This product is intended for household use only. It is not intended for commercial use.

This product is covered by a limited one-year warranty. Coverage is subject to limits and exclusions. See warranty for details.

## Contents

- Junior guitar
- 20 W amplifier
- 6 strings
- 2 picks
- Shoulder strap
- Carrying bag
- Guitar cable
- Digital mini clip-on tuner
- CR2032 battery (for tuner)

## Safety Precautions

- To avoid the risk of high voltage electric shock, do not attempt to open units.
- Do not attempt to repair units yourself; have them serviced by qualified personnel.
- Before connecting electrical equipment to the main power supply, make sure the outlet voltage corresponds to the voltage stated on the product's rating label.
- For all electrical products, align the plug properly and insert it fully. Do not overload the power outlet. If the power cord is damaged, it must be replaced by the manufacturer or qualified personnel in order to avoid a hazard.
- Do not expose these products, power cords and plugs to any type of liquid or moisture. Do not touch the power plug or the unit with wet hands.
- Switch off and unplug the guitar and amp when they are not in use.
- Do not store your products in places prone to high humidity, high temperature, dust, or static electricity.
- Do not drop the products.
- Do not use strong cleaners or solvents to clean these products.

## Guitar Parts:

1. Tuning pegs
2. Truss rod hole
3. Nut
4. Neck
5. Frets
6. Pickups
7. Body
8. Pickup switch
9. Volume/tone controls
10. Bridge
11. Input jack

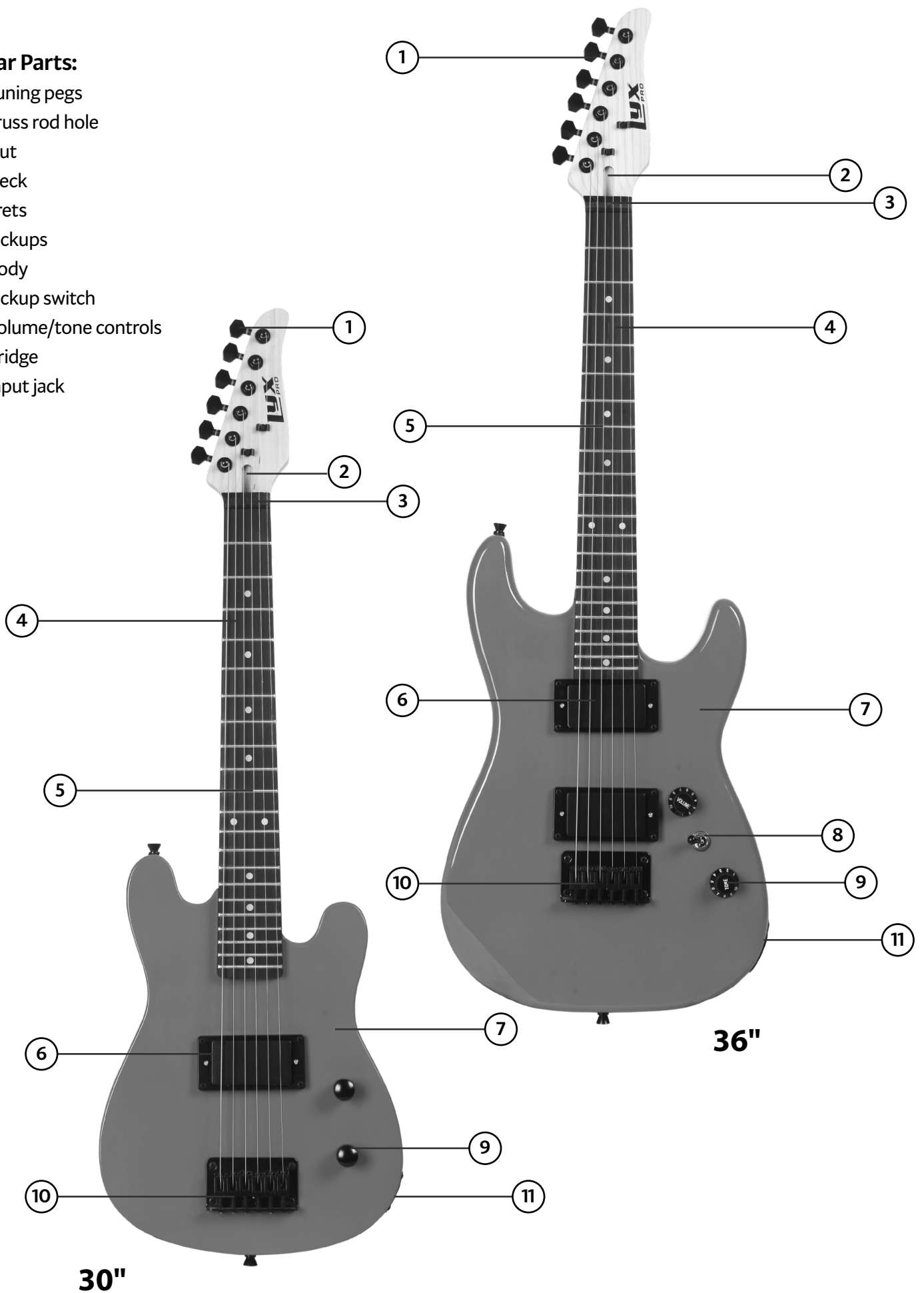

## Tuning

Guitars have different headstock shapes, but the basic method to tune your instrument's strings is the same.

For easy tuning, see the section on your LyxPro Digital Mini Clip-On Instrument Tuner.

For manual tuning, you can use a tuning fork, electronic tuner, pitch pipe, or online tuner or app. Tune from a pitch below the correct pitch up to the correct pitch instead of down from a higher pitch. This eliminates slacking of strings and reduces the chance of strings going out of tune due to slippage as you play.

If you use an A-440 tuning fork or pitch pipe, start by tuning the second thickest string and move to the thinner one by one. After tuning the five strings, go back to the thickest string and tune the string. The following table shows standard tuning.

## Guitar

6th (Top)	5th	4th	3rd	2nd	1st
E	A	D	G	B	E

## Truss Rod Adjustment

Environmental conditions like temperature and humidity, as well as string tension, can cause bowing of the guitar neck. If your instrument has an adjustable truss rod, you can try to adjust it to keep the neck as straight as possible.

Truss rod in "flat" position

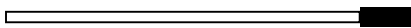

Tightening the truss rod counterclockwise causes the neck to curve downward.

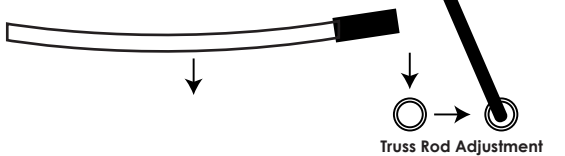

Tightening the truss rod clockwise causes the neck to curve upward.

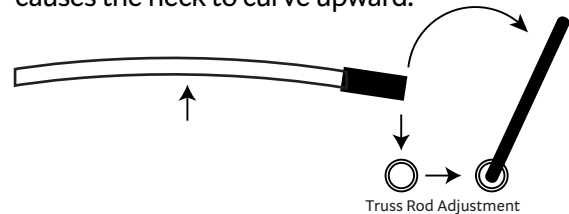

## Changing Strings

Replace one string at a time.

Unwind the old string at the tuning machine.

Remove the old string through the hole on the back of your guitar.

Insert a new string through the corresponding hole.

Run the string over the neck and the nut.

Feed the string through the hole in the tuning machine.

Bend the string around the post and wind the string using the tuning peg.

## Guitar Care and Maintenance

Keep your instrument in a case or carrying bag when transporting or storing it.

Do not place any objects on the top of your instrument.

Regularly clean your guitar, including the finger board, with a clean, dry, soft cloth.

Polish the finished surface with an appropriate guitar polish.

Humidity and temperature affect your guitar. Avoid exposing it to extreme temperatures, high humidity, and excessively dry environments.

## Digital Mini Clip-On Tuner Parts:

1. LCD screen
2. Function button
3. Axis
4. Rotating clip
5. Battery compartment

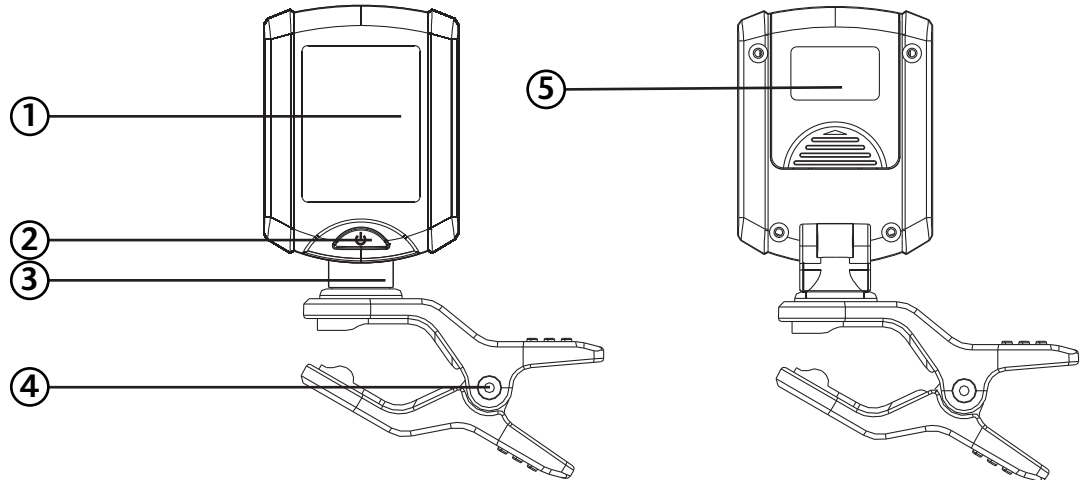

## Inserting the Battery

Before using your new tuner, you must insert the battery included with the device.

1. Remove battery cover: Press the front of the battery cover and then slide it back.
2. Place the battery into the compartment with the negative (-) pole facing inward. Replace the cover and press down to lock it in place.
3. Once done, the tuner will be on and ready to use.
4. The tuner will power off after 3 minutes of inactivity.

## To Use

Tuner must be clipped onto your guitar to work.

Press the power button  to turn the unit on. Press and hold for 2 seconds to turn the unit off. The tuner will automatically power off after 3 minutes of inactivity.

Press once for each setting: (c) chromatic, (g) guitar, (b) bass, (v) violin and (u) ukulele.

When a string is plucked, the LCD screen will display whether the note is flat, sharp, or in tune. You can then tighten or slacken the string by turning the tuning peg to change the pitch until that string is in tune.

## Tuning your Guitar

1. Clip the tuner onto the headstock of your guitar and adjust for easy viewing.
2. Tune from the thickest string to the thinnest string.
3. Pluck the string and look at the digital readout. The LCD will display the name of the note. Look for one of three things:
  - a. Flat note: The indicator bar on the screen points left. Readout is white.
  - b. Sharp note: The indicator bar on the screen points right. Readout is white.
  - c. In tune: The indicator bar points straight up in the center of the screen. Readout is green.
4. If the note registers as sharp or flat, tighten or loosen the string to change the pitch until it is in tune.

## Guitar Specifications

30 inch guitar dimensions: 29.9" x 10.2" x 1.7"

30 inch guitar weight: 8.6 lbs.

36 inch guitar dimensions: 34.6" x 11" x 1.7"

36 inch guitar weight: 9.7 lbs.

Number of strings: 6

Body shape: Double cutout

Body wood: Paulownia wood

Orientation: Right-handed

Neck wood: Canadian maple

Joint: Bolt-on

Truss rod: Standard

Fingerboard material: Engineer wood

Number of frets: 21

Inlays: Dots

36 inch guitar pickup controls: 3 way

Control dials: Volume, tone

Bridge: Fixed

## Tuner Specifications:

A4 frequency: 440 Hz

Tuning item: Chromatic, guitar, bass, violin, ukulele

Tuning range: 0A (27.5 Hz) - 8C (4186.01 Hz)

Dimensions: 2.1" x 1.1" x 3.1"

Weight: 1.1 oz.

## Amplifier Parts:

1. AUX input: Connect an audio source such as an MP3 player or mobile phone to play along with your recorded music.
2. Instrument input: Connect your guitar with the provided guitar cable.
3. Grind button: Turn on/off the gain control.
4. Gain: Adjust the amount of the amplifier gain.
5. Bass: Adjust the bass of the output.
6. Treble: Adjust the treble of the output.
7. Volume: Adjust the output volume.
8. Headphones: Connect headphones with a 1/4" TRS jack.
9. Power switch: Turn the amplifier on and off.

## Amplifier Specifications:

Power: 20 W

Speaker: 6.5"/4 ohm

Equalization: Treble, bass, gain, grind

Jacks: Headphone, MP3

Dimensions: 11.6" x 11.2" x 4.1"

Weight: 5.7 lbs.



**General Specifications:**

Product type: Guitar starter kit

Location: Indoor or outdoor use

Installation required: No

Adult assembly required: No

Additional tools required: No

Country of origin: China

Warranty included: Yes

Warranty length: 1 year

**Customer Service:**

info@lyxpro.com

866-849-3049

[www.lyxpro.com](http://www.lyxpro.com)

C&A Marketing, Inc.  
114 Tived Lane East  
Edison, NJ 08837 USA

info@lyxpro.com  
MADE IN CHINA

LyxPro is a trademark of  
C&A IP Holdings LLC in the US  
©2021. All Rights Reserved

All other products, brand names,  
company names, and logos are  
trademarks of their respective  
owners, used merely to identify their  
respective products, and are not  
meant to connote any sponsorship,  
endorsement, or approval.

## LIMITED WARRANTY TO ORIGINAL CONSUMER

This **LyxPro Junior Electric Guitar and Starter Kit ("Product")**, including any accessories included in the original packaging, as supplied and distributed new by an authorized retailer is warranted by **C&A Marketing, Inc. (the "Company")** to the original consumer purchaser only, against certain defects in material and workmanship ("**Warranty**") as follows:

To receive Warranty service, the original consumer purchaser must contact the Company or its authorized service provider for problem determination and service procedures. Proof of purchase in the form of a bill of sale or receipted invoice, evidencing that the Product is within the applicable Warranty period(s), **MUST** be presented to the Company or its authorized service provider in order to obtain the requested service.

Service options, parts availability, and response times may vary and may change at any time. In accordance with applicable law, the Company may require that you furnish additional documents and/or comply with registration requirements before receiving warranty service. Please contact our customer service for details on obtaining warranty service:

**Email: [info@lyxpro.com](mailto:info@lyxpro.com)**

**Phone: 866-849-3049**

Shipping expenses to the Company's Return Facility are not covered by this warranty and must be paid by the consumer. The consumer likewise bears all risk of loss or further damage to the Product until delivery to said facility.

**EXCLUSIONS AND LIMITATIONS** The Company warrants the Product against defects in materials and workmanship under normal use for a period of **ONE (1) YEAR** from the date of retail purchase by the original end-user purchaser ("**Warranty Period**"). If a hardware defect arises and a valid claim is received within the Warranty Period, the Company, at its sole option and to the extent permitted by law, will either (1) repair the Product defect at no charge, using new or refurbished replacement parts, (2) exchange the Product with a Product that is new or which has been manufactured from new or serviceable used parts and is at least functionally equivalent to the original device, or (3) refund the purchase price of the Product.

A replacement Product or part thereof shall enjoy the warranty of the original Product for the remainder of the Warranty Period, or ninety (90) days from the date of replacement or repair, whichever provides you longer protection. When a Product or part is exchanged, any replacement item becomes your property, while the replaced item becomes the Company's property. Refunds can only be given if the original Product is returned.

This Warranty does not apply to:

- (a) Any non-LyxPro Junior Electric Guitar and Starter Kit product, hardware or software, even if packaged or sold with the Product;
- (b) Damage caused by use with non-LyxPro Junior Electric Guitar and Starter Kit products;
- (c) Damage caused by accident, abuse, misuse, flood, fire, earthquake, or other external causes;
- (d) Damage caused by operating the Product outside the permitted or intended uses described by the Company;
- (e) Damage caused by third party services;
- (f) A Product or part that has been modified to alter functionality or capability without the written permission of the Company;
- (g) Consumable parts, such as batteries, fuses, and bulbs;
- (h) Cosmetic damage; or
- (i) If any LyxPro Junior Electric Guitar and Starter Kit serial number has been removed or defaced.

This Warranty is valid only in the country where the consumer purchased the Product, and only applies to Products purchased and serviced in that country.

The Company does not warrant that the operation of the Product will be uninterrupted or error-free. The Company is not responsible for damage arising from your failure to follow instructions relating to its use.

**NOTWITHSTANDING ANYTHING TO THE CONTRARY AND TO THE MAXIMUM EXTENT PERMITTED BY APPLICABLE LAW, THE COMPANY PROVIDES THE PRODUCT "AS-IS" AND "AS-AVAILABLE" FOR YOUR CONVENIENCE AND THE COMPANY AND ITS LICENSORS AND SUPPLIERS EXPRESSLY DISCLAIM ALL WARRANTIES AND CONDITIONS, WHETHER EXPRESSED, IMPLIED, OR STATUTORY, INCLUDING THE WARRANTIES OF MERCHANTABILITY, FITNESS FOR A PARTICULAR PURPOSE, TITLE, QUIET ENJOYMENT, ACCURACY, AND NON-INFRINGEMENT OF THIRD-PARTY RIGHTS. THE COMPANY DOES NOT GUARANTEE ANY SPECIFIC RESULTS FROM THE USE OF THE PRODUCT, OR THAT THE COMPANY WILL CONTINUE TO OFFER OR MAKE AVAILABLE THE PRODUCT FOR ANY PARTICULAR LENGTH OF TIME. THE COMPANY FURTHER DISCLAIMS ALL WARRANTIES AFTER THE EXPRESS WARRANTY PERIOD STATED ABOVE.**

**YOU USE THE PRODUCT AT YOUR OWN DISCRETION AND RISK. YOU WILL BE SOLELY RESPONSIBLE FOR (AND THE COMPANY DISCLAIMS) ANY AND ALL LOSS, LIABILITY, OR DAMAGES RESULTING FROM YOUR USE OF THE PRODUCT.**

**NO ADVICE OR INFORMATION, WHETHER ORAL OR WRITTEN, OBTAINED BY YOU FROM THE COMPANY OR THROUGH ITS AUTHORIZED SERVICE PROVIDERS SHALL CREATE ANY WARRANTY.**

**IN NO EVENT WILL THE COMPANY'S TOTAL CUMULATIVE LIABILITY ARISING FROM OR RELATED TO THE PRODUCT, WHETHER IN CONTRACT OR TORT OR OTHERWISE EXCEED THE FEES ACTUALLY PAID BY YOU TO THE COMPANY OR ANY OF ITS AUTHORIZED RESELLERS FOR THE PRODUCT AT ISSUE IN THE LAST YEAR FROM YOUR PURCHASE. THIS LIMITATION IS CUMULATIVE AND WILL NOT BE INCREASED BY THE EXISTENCE OF MORE THAN ONE INCIDENT OR CLAIM. THE COMPANY DISCLAIMS ALL LIABILITY OF ANY KIND OF ITS LICENSORS AND SUPPLIERS. IN NO EVENT WILL THE COMPANY OR ITS LICENSORS, MANUFACTURERS, AND SUPPLIERS BE LIABLE FOR ANY INCIDENTAL, DIRECT, INDIRECT, SPECIAL, PUNITIVE, OR CONSEQUENTIAL DAMAGES (SUCH AS, BUT NOT LIMITED TO, DAMAGES FOR LOSS OF PROFITS, BUSINESS, SAVINGS, DATA, OR RECORDS) CAUSED BY THE USE, MISUSE, OR INABILITY TO USE THE PRODUCT.**

Nothing in these terms shall attempt to exclude liability that cannot be excluded under applicable law. Some countries, states, or provinces do not allow the exclusion or limitation of incidental or consequential damages or allow limitations on warranties, so certain limitations or exclusions may not apply to you. This warranty gives you specific legal rights, and you may have other rights that vary from state to state or province to province. Contact your authorized retailer to determine if another warranty applies.